

**Conference
Area One**

In Use



level four **4**

→ Suites 400-412

Restrooms

 **SMITH**

SMITH

A Curved Face Sign System

Simple. Elegant. Functional.
Arcadia offers functional design,
from a single module to a
comprehensive system.

Series 1000 Arcadia™ Vertical

Arcadia Series 1000 features an extruded aluminum base, designed to hold a variety of modular insert components, including printed paper, injected molded message strips, ADA plaques, and more...

Arcadia's unique, patent pending Contour edge profiles and decorative design options truly distinguish this system, offering a well-designed, yet clean and simple curved-face signage solution.

Features & Benefits:

- Standard and Custom Sizes Available
- Broad Range of Colors and Finishes
- Extruded Aluminum Base
- ADA Compatible
- User Lettering Options:
 - Compatible with APCO's SignWord Pro Software and Supplies, as well as Numerous, Market-Available Paper sizes
- Concealed Fasteners
- Two Options for Top/Bottom Caps:
 - 1) Molded Plastic Caps
 - 2) Full Aluminum Closures

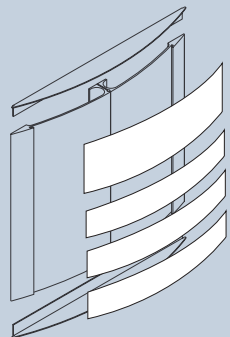
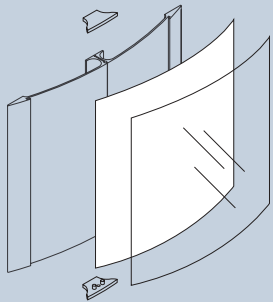

Standard Widths displayed below
Standard Heights are Variable

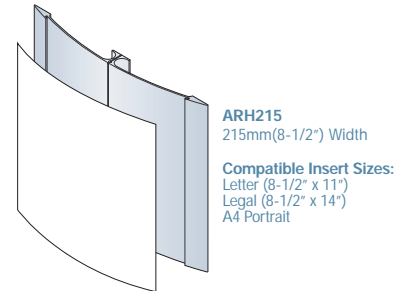
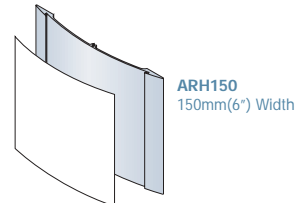
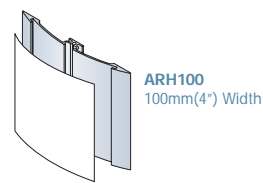
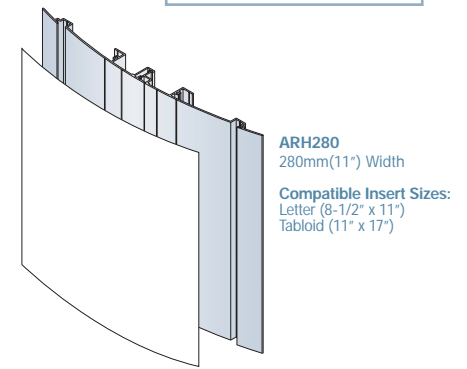
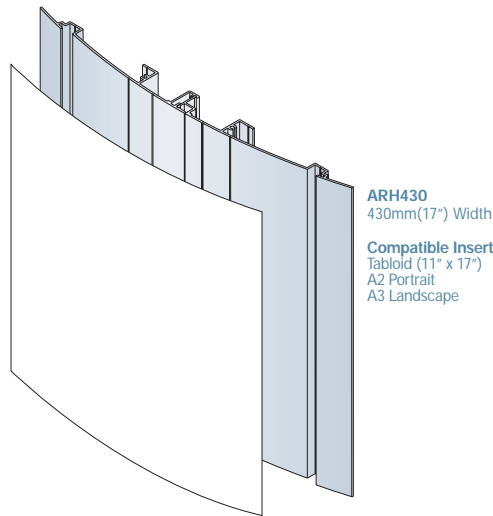

Series 2000
Arcadia™ Horizontal

Perhaps the primary benefit of the Arcadia system is its design flexibility. Simply rotating the components in Series 1000 yields the entirely different look and feel of Series 2000. With Contour edge profiles at top and bottom, a new range of creative solutions is made possible.

Ideal for:

- Personnel Signs
- Room and Suite Identification
- Ceiling and Wall Projecting Signs
- Directional and Directory Modules

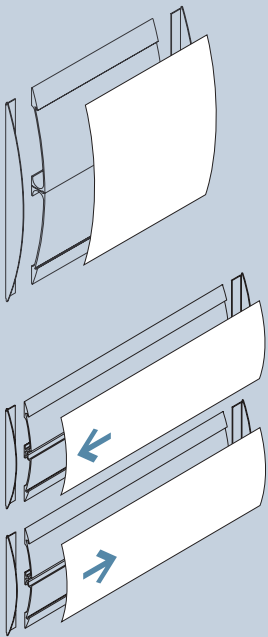

Insert Removal
Front Loaded Modular Insert Facilitates Easy Removal with Suction Cup Tool

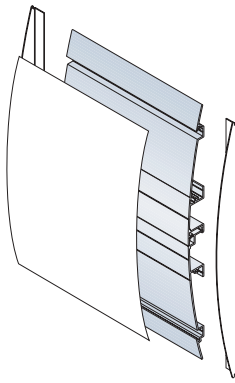

ARH280H
280mm (11") Height

Compatible Insert Sizes:
Letter (8-1/2" x 11")
Tabloid (11" x 17")

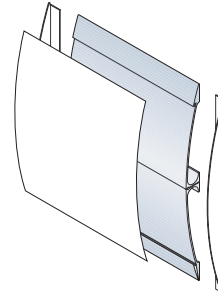

ARH215H
215mm (8-1/2") Height

Compatible Insert Sizes
Letter (8-1/2" x 11")
Legal (8-1/2" x 14")
A4 Landscape

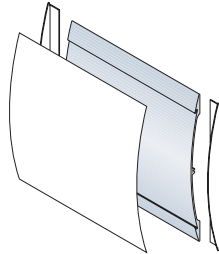

ARH150H
150mm (6") Height

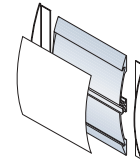

ARH100H
100mm (4") Height



5



7



6



8

Series 3000
Arcadia™ Free Standing

More than signs, Arcadia's Series 3000 modules are completely portable and reconfigurable Information Centers.

Constructed of durable extruded aluminum components, Arcadia's Series 3000 offers one of the highest quality, yet simple and easy solutions available.

With numerous curved-face display options, from paper inserts with laser printed graphics and injection molded message strips to decorative metallic inserts and brochure holders, Series 3000 does it all.

Features:

- Numerous Insert & Display Options
 - Full Sheet, Digital Graphic Inserts
 - Injection Molded Message Strips
 - Decorative Metallic Inserts
 - User Lettered Paper Inserts
 - POP Displays & Literature Holders
- Solid/Sturdy Aluminum Base
 - Reinforced w/ Weighted Steel Bearings for Added Stability

Useful for:

- Events, Exhibits, Museums, Galleries, Lobbies, Airports, Etc....



Literature Holder
Optional Literature Holder Available for 280(11") & 430(17") modules.

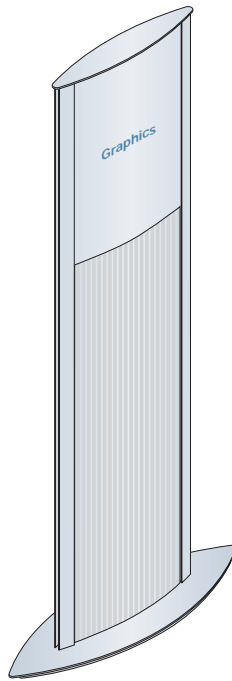

ARFS-280
280mm (11") Width
Standard Heights
48"(1220mm), 60"(1524mm)
Compatible Insert Sizes
• Letter (8-1/2" x 11")
• Tabloid (11" x 17")

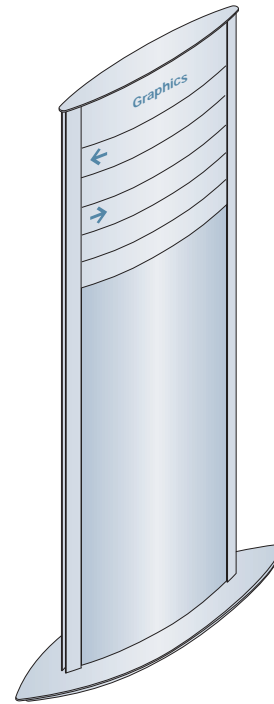

ARFS-430
430mm (17") Width
Standard Heights
48"(1220mm), 60"(1524mm), 66"(1676mm)
Compatible Insert Sizes
• Tabloid (11" x 17")
• A2 Portrait
• A3 Landscape



Arcadia Insert Options

The Arcadia system offers a wide range of front loaded, interchangeable inserts, maximizing creative possibilities. Graphic options include permanent screen printing, user updateable paper, Braille/tactile graphics for ADA compliance, and more...

* Decorative Metal Inserts

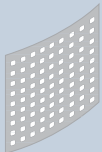

DMP1
Perforated Metal
Squares Pattern

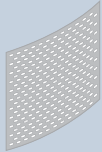

DMP2
Perforated Metal
Capsules Pattern

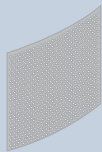

DMP3
Perforated Metal
Micro-Perf Pattern

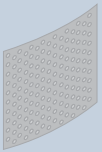

DMS4
Solid Laminate
Dimpled Texture



DMS5
Solid Laminate
Ribbed Texture

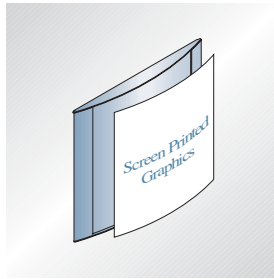

ARI
Opaque Insert with Permanent Graphics

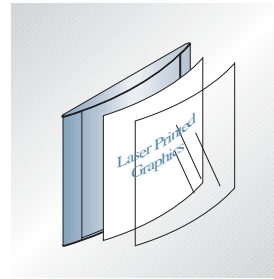

ARI-CL
ClearLens with Paper Insert

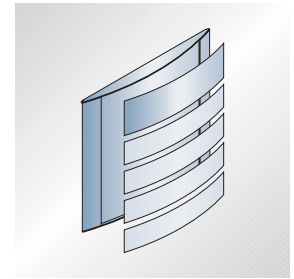

ARI-MB
Injection Molded Message Strips
• 30mm, 45mm, 60mm Standard Heights

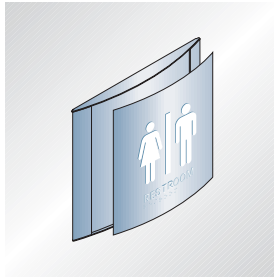

ARI-A
ADA Plaque Insert

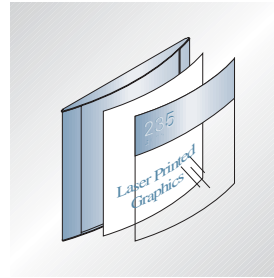

ARI-ACL
ADA Band Attached to ClearLens

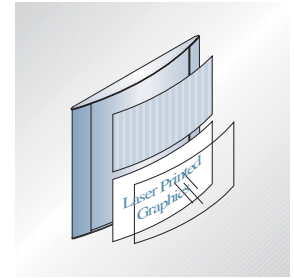

ARI-DM
Decorative Metal Inserts *

Update Arcadia Inserts in 3 Easy Steps

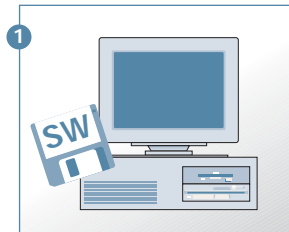

With SignWord Pro Software, enter your message and symbols using pre-established formats or your own custom layouts.

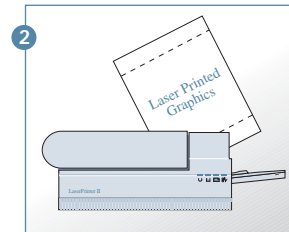

Print the image on a special paper that is perforated to fit the sign holder.

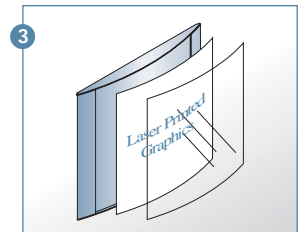

Punch out the sign insert, place it in the holder, flex in the clear plastic lens and PRESTO – in less than 60 seconds you have a completed sign!

Attachment Methods

From walls and ceilings to desk tops and office panel systems, Arcadia offers a range of quality, well-engineered attachment solutions for every environment, every situation.

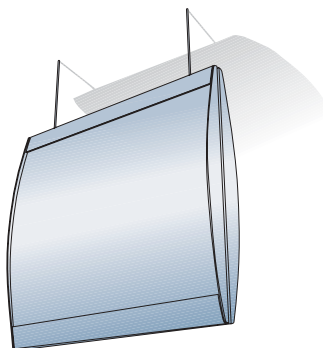

ARSCM
Suspended Ceiling

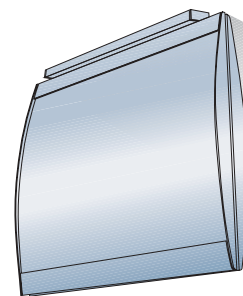

ARFCM
Flush Ceiling

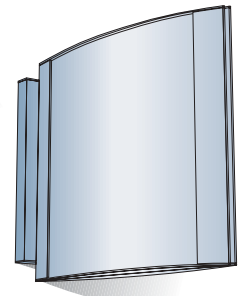

ARPWM
Projecting Wall

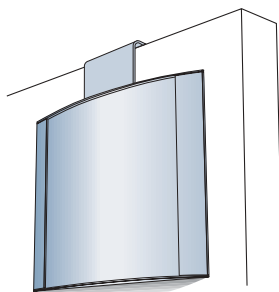

ARPCA
Office Panel - Aluminum Clip Attachment

Also available:
ARPCW - Stainless Wire Attachment

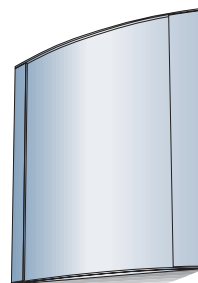

ARSTD
Wall - Via Concealed Mechanical
Fasteners or Double Sided Adhesive

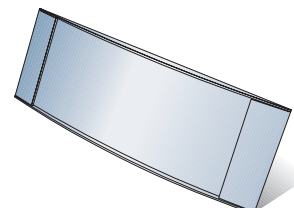

ARDSA
Desk Top



APCO Graphics, Inc.
 USA Headquarters
 388 Grant Street, SE
 Atlanta, GA, USA 30312-2227
 Phone: 404-688-9000
 Fax: 404-577-3847
 Web: www.apcosigns.com
 Email: sales@apcosigns.com

APCO United Kingdom
 LKH Estate, Tickhill Road
 Balby, Doncaster
 England DN4 8QG
 Phone: 0.1302.311.121
 Fax: 0.1302.311.852
 Email: apco@norking.com